

(NOTE: SOLID OAK EXECUTIVE LOCKER SHOWN WITHOUT SIDE PANEL OR CROWN MOLDING. PLEASE ORDER SEPARATELY.)

MODEL #12168
DOUBLE TIER SOLID OAK
EXECUTIVE LOCKER - 1 WIDE

(2) LOCKER COMPARTMENTS
EACH COMPARTMENT:
14 3/4" W x 34 3/4" H x 16 3/4" D

SIDE VIEW

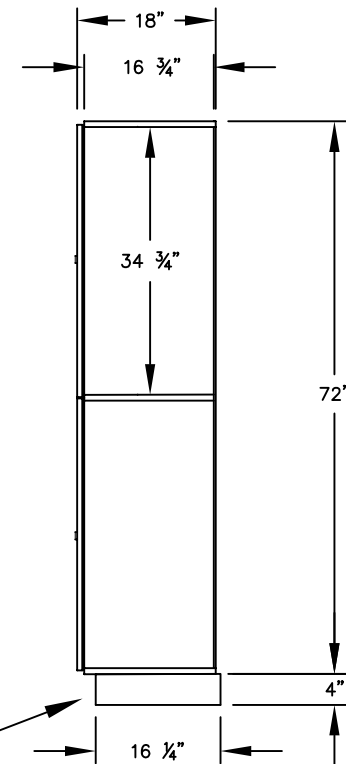

(BASES ARE MADE OF INDUSTRIAL GRADE PARTICLEBOARD AND ARE COVERED IN A DURABLE BLACK LAMINATE. PLEASE SET BASE TO ALLOW 5/8" BETWEEN THE BACK OF THE LOCKER AND THE WALL FOR AIR VENTILATION.)

MODEL #12168

18" DEEP DOUBLE TIER
SOLID OAK EXECUTIVE LOCKER
SIX FEET HIGH (ADD 4" FOR BASE)

AVAILABLE FINISHES:
LIGHT OAK, MEDIUM OAK, DARK OAK

DRAWN: 03/12

***Established in 1936, Salsbury Industries
is the industry leader in manufacturing and distributing
quality lockers and storage solutions.***

1010 E. 62ND STREET
LOS ANGELES, CA 90001
PHONE: (800) 562-5377
FAX: (800) 562-5399
email: engineering@lockers.com