

(NOTE: PREMIER LOCKER SHOWN WITHOUT SIDE PANEL OR SLOPING HOOD. PLEASE ORDER SEPERATELY.)

MODEL #15-43161-R  
 15" WIDE TRIPLE TIER  
 PREMIER WOOD LOCKER – 1 WIDE  
 WITH RESETTABLE COMBINATION LOCKS

(3) LOCKER COMPARTMENTS  
 EACH COMPARTMENT:  
 13-3/4" W x 22-3/4" H x 19-3/4" D

**SIDE VIEW**

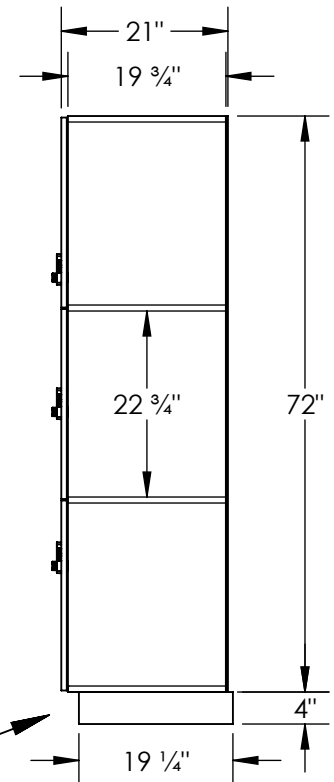

(BASES ARE MADE OF INDUSTRIAL GRADE PARTICLEBOARD AND ARE COVERED IN A DURABLE BLACK LAMINATE. PLEASE SET BASE TO ALLOW 5/8" BETWEEN THE BACK OF THE LOCKER AND THE WALL FOR AIR VENTILATION.)

**MODEL #15-43161-R**

15" WIDE TRIPLE TIER  
 PREMIER WOOD LOCKER  
 WITH RESETTABLE COMBINATION LOCKS  
 SIX FEET HIGH (ADD 4" FOR BASE)

AVAILABLE FINISHES: ARTIC WHITE, WINTER FOG,  
 CARBON MESH, SILVER TEAK, RED OAK, SKYLINE WALNUT

DRAWN: 6/2024

18300 CENTRAL AVENUE  
 CARSON, CA 90746-4008  
 PHONE: (800) 562-5377  
 FAX: (800) 562-5399  
 email: [engineering@lockers.com](mailto:engineering@lockers.com)