

MODEL #15-47168
15" WIDE DOUBLE TIER 'S' STYLE
PREMIER WOOD LOCKER – 1 WIDE
WITH STANDARD HASPS

(2) LOCKER COMPARTMENTS
 EACH COMPARTMENT:
 13-3/4" W x 40-3/4" H x 16-3/4" D

(THE DOUBLE TIER 'S' STYLE PREMIER
 LOCKER INCREASES EACH COMPARTMENT
 ON ONE SIDE TO ACCOMMODATE GARMENTS.)

SIDE VIEW

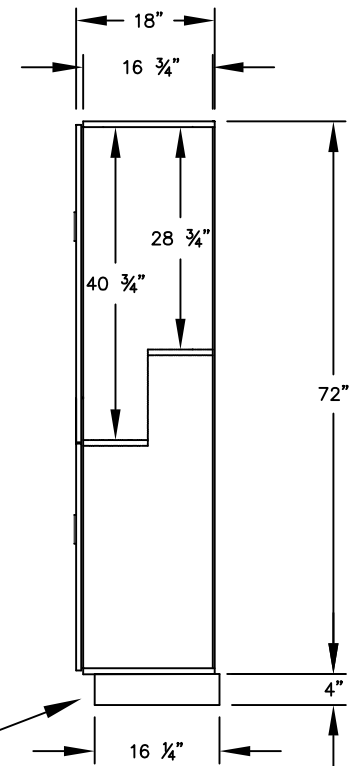

(NOTE: PREMIER LOCKER SHOWN
 WITHOUT SIDE PANEL OR SLOPING
 HOOD. PLEASE ORDER SEPERATELY.)

(BASES ARE MADE OF INDUSTRIAL GRADE
 WOOD AND ARE COVERED IN A DURABLE
 BLACK LAMINATE. PLEASE SET BASE
 TO ALLOW 5/8" BETWEEN THE BACK OF THE
 LOCKER AND THE WALL FOR AIR VENTILATION.)

MODEL #15-47168

15" WIDE DOUBLE TIER 'S' STYLE
PREMIER WOOD LOCKER
WITH STANDARD HASPS
SIX FEET HIGH (ADD 4" FOR BASE)

AVAILABLE LOCKER FINISHES: ARCTIC WHITE, WINTER FOG,
 CARBON MESH, SILVER TEAK, RED OAK, SKYLINE WALNUT

AVAILABLE HASP FINISHES: BLACK OR SILVER

DRAWN: 12/2025

***Established in 1936, Salsbury Industries is the industry
 leader in manufacturing and distributing quality lockers.***

18300 CENTRAL AVENUE
 CARSON, CA 90746-4008
 PHONE: (800) 562-5377
 FAX: (800) 562-5399
 email: engineering@lockers.com