

(NOTE: PREMIER LOCKER SHOWN WITHOUT SIDE PANEL OR SLOPING HOOD. PLEASE ORDER SEPERATELY.)

MODEL #15-47368-R
15" WIDE DOUBLE TIER 'S' STYLE PREMIER WOOD LOCKER – 3 WIDE WITH RESETTABLE COMBINATION LOCKS

(6) LOCKER COMPARTMENTS
 EACH COMPARTMENT:
 13-3/4" W x 40-3/4" H x 16-3/4" D

(THE DOUBLE TIER 'S' STYLE PREMIER LOCKER INCREASES EACH COMPARTMENT ON ONE SIDE TO ACCOMMODATE GARMENTS.)

SIDE VIEW

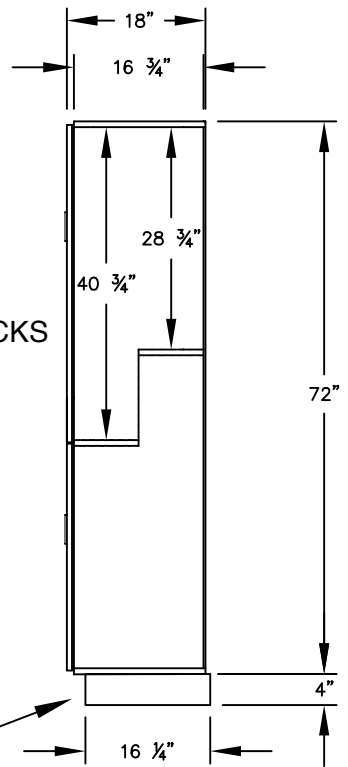

(BASES ARE MADE OF INDUSTRIAL GRADE WOOD AND ARE COVERED IN A DURABLE BLACK LAMINATE. PLEASE SET BASE TO ALLOW 5/8" BETWEEN THE BACK OF THE LOCKER AND THE WALL FOR AIR VENTILATION.)

MODEL #15-47368-R

15" WIDE DOUBLE TIER 'S' STYLE PREMIER WOOD LOCKER WITH RESETTABLE COMBINATION LOCKS SIX FEET HIGH (ADD 4" FOR BASE)

AVAILABLE LOCKER FINISHES: ARCTIC WHITE, WINTER FOG, CARBON MESH, SILVER TEAK, RED OAK, SKYLINE WALNUT

AVAILABLE LOCK FINISHES: BLACK OR SILVER

DRAWN: 12/2025

Established in 1936, Salsbury Industries is the industry leader in manufacturing and distributing quality lockers.

18300 CENTRAL AVENUE
 CARSON, CA 90746-4008
 PHONE: (800) 562-5377
 FAX: (800) 562-5399
 email: engineering@lockers.com