

(NOTE: DESIGNER LOCKER SHOWN WITHOUT SIDE PANEL OR SLOPING HOOD. PLEASE ORDER SEPARATELY.)

MODEL #18-24164
18" WIDE FOUR TIER
DESIGNER WOOD LOCKER – 1 WIDE
WITH RECESSED HASPS

(4) LOCKER COMPARTMENTS
 EACH COMPARTMENT:
 16-3/4" W x 17" H x 22-3/4" D

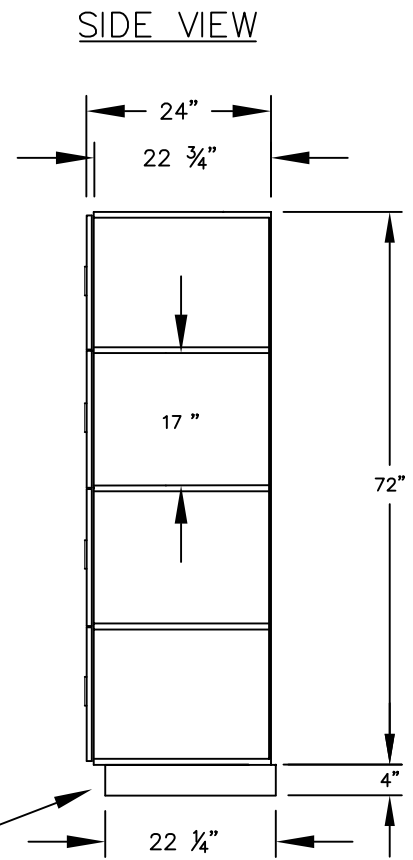

(BASES ARE MADE OF INDUSTRIAL GRADE PARTICLEBOARD AND ARE COVERED IN A DURABLE BLACK LAMINATE. PLEASE SET BASE TO ALLOW 5/8" BETWEEN THE BACK OF THE LOCKER AND THE WALL FOR AIR VENTILATION.)

MODEL #18-24164

18" WIDE FOUR TIER
 DESIGNER WOOD LOCKER
 WITH RECESSED HASPS
 SIX FEET HIGH (ADD 4" FOR BASE)

AVAILABLE FINISHES: GRAY, BLUE,
 BLACK, MAPLE, CHERRY OR MAHOGANY

DRAWN: 1/2025

Established in 1936, Salsbury Industries is the industry leader in manufacturing and distributing quality lockers.

18300 CENTRAL AVENUE
 CARSON, CA 90746-4008
 PHONE: (800) 562-5377
 FAX: (800) 562-5399
 email: engineering@lockers.com