

(NOTE: PREMIER LOCKER SHOWN WITHOUT SIDE PANEL OR SLOPING HOOD. PLEASE ORDER SEPERATELY.)

MODEL #18-43368-E
 18" WIDE TRIPLE TIER
 PREMIER WOOD LOCKER – 3 WIDE
 WITH ELECTRONIC LOCKS

(9) LOCKER COMPARTMENTS
 EACH COMPARTMENT:
 16-3/4" W x 22-3/4" H x 16-3/4" D

SIDE VIEW

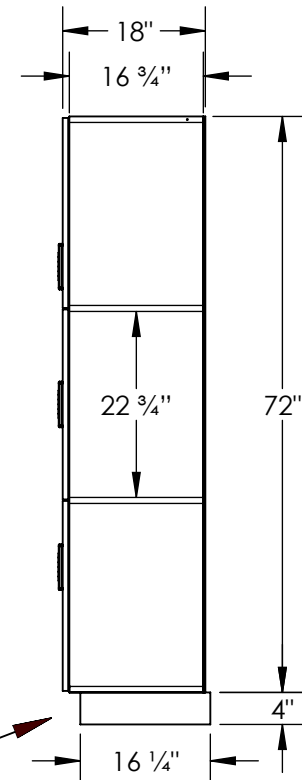

(BASES ARE MADE OF INDUSTRIAL GRADE PARTICLEBOARD AND ARE COVERED IN A DURABLE BLACK LAMINATE. PLEASE SET BASE TO ALLOW 5/8" BETWEEN THE BACK OF THE LOCKER AND THE WALL FOR AIR VENTILATION.)

MODEL #18-43368-E

18" WIDE TRIPLE TIER
 PREMIER WOOD LOCKER
 WITH ELECTRONIC LOCKS
 SIX FEET HIGH (ADD 4" FOR BASE)

AVAILABLE FINISHES: ARTIC WHITE, WINTER FOG,
 CARBON MESH, SILVER TEAK, RED OAK, SKYLINE WALNUT

DRAWN: 6/2024

18300 CENTRAL AVENUE
 CARSON, CA 90746-4008
 PHONE: (800) 562-5377
 FAX: (800) 562-5399
 email: engineering@lockers.com