

(NOTE: DESIGNER LOCKER SHOWN WITHOUT SIDE PANEL OR SLOPING HOOD. PLEASE ORDER SEPARATELY.)

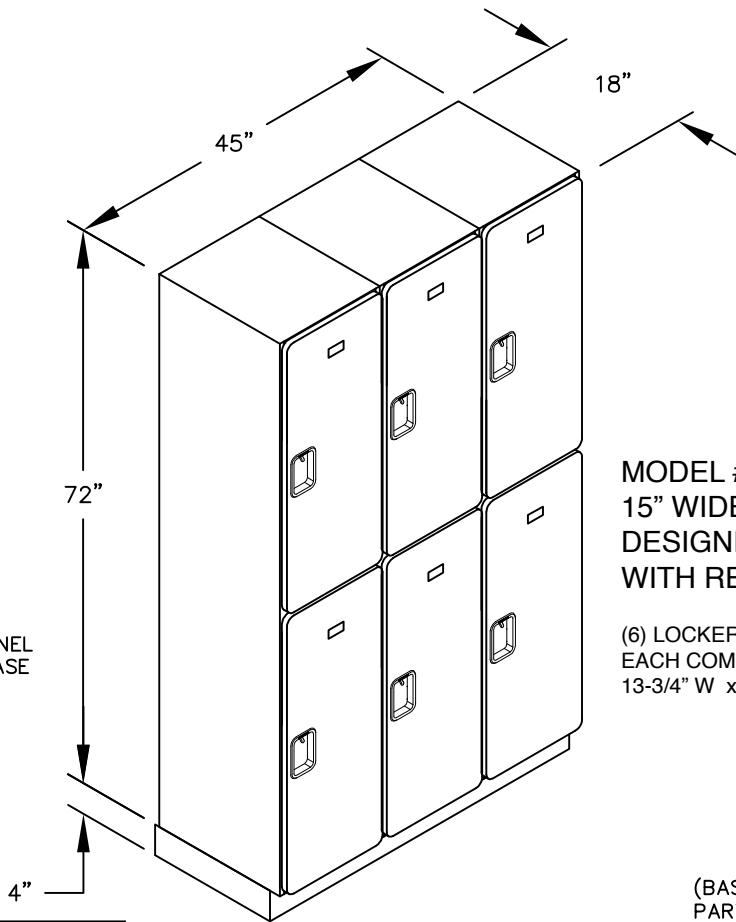

MODEL #22368  
15" WIDE DOUBLE TIER  
DESIGNER WOOD LOCKER – 3 WIDE  
WITH RECESSED HASPS

(6) LOCKER COMPARTMENTS  
EACH COMPARTMENT:  
13-3/4" W x 34-3/4" H x 16-3/4" D

(BASES ARE MADE OF INDUSTRIAL GRADE PARTICLEBOARD AND ARE COVERED IN A DURABLE BLACK LAMINATE. PLEASE SET BASE TO ALLOW 5/8" BETWEEN THE BACK OF THE LOCKER AND THE WALL FOR AIR VENTILATION.)

SIDE VIEW

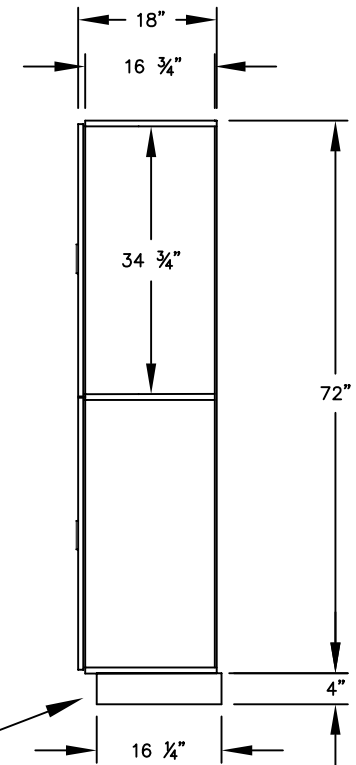

MODEL #22368

15" WIDE DOUBLE TIER  
DESIGNER WOOD LOCKER  
WITH RECESSED HASPS  
SIX FEET HIGH (ADD 4" FOR BASE)

AVAILABLE FINISHES: GRAY, BLUE,  
BLACK, MAPLE, CHERRY OR MAHOGANY

DRAWN: 1/2025

***Established in 1936, Salsbury Industries is the industry leader in manufacturing and distributing quality lockers.***

18300 CENTRAL AVENUE  
CARSON, CA 90746-4008  
PHONE: (800) 562-5377  
FAX: (800) 562-5399  
email: [engineering@lockers.com](mailto:engineering@lockers.com)