

(NOTE: DESIGNER LOCKER SHOWN WITHOUT SIDE PANEL OR SLOPING HOOD. PLEASE ORDER SEPARATELY.)

**MODEL #35151**  
**12" WIDE FIVE TIER BOX STYLE**  
**DESIGNER WOOD LOCKER – 1 WIDE**  
**WITH RECESSED HASPS**

(5) LOCKER COMPARTMENTS  
 EACH COMPARTMENT:  
 10-3/4" W x 11" H x 19-3/4" D

SIDE VIEW

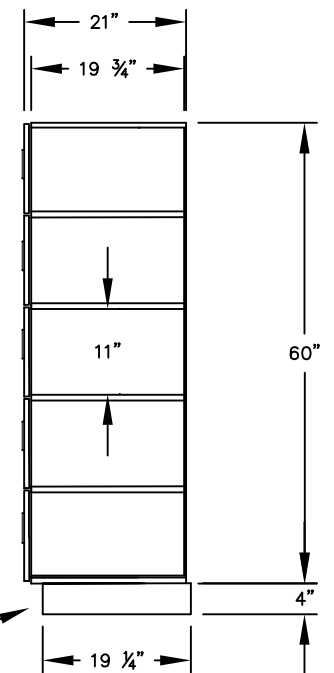

(BASES ARE MADE OF INDUSTRIAL GRADE PARTICLEBOARD AND ARE COVERED IN A DURABLE BLACK LAMINATE. PLEASE SET BASE TO ALLOW 5/8" BETWEEN THE BACK OF THE LOCKER AND THE WALL FOR AIR VENTILATION.)

**MODEL #35151**

**12" WIDE FIVE TIER BOX STYLE**  
**DESIGNER WOOD LOCKER**  
**WITH RECESSED HASPS**  
**FIVE FEET HIGH (ADD 4" FOR BASE)**

AVAILABLE FINISHES: GRAY, BLUE,  
 BLACK, MAPLE, CHERRY OR MAHOGANY

DRAWN: 1/2025

***Established in 1936, Salsbury Industries is the industry leader in manufacturing and distributing quality lockers.***

18300 CENTRAL AVENUE  
 CARSON, CA 90746-4008  
 PHONE: (800) 562-5377  
 FAX: (800) 562-5399  
 email: [engineering@lockers.com](mailto:engineering@lockers.com)