

MODEL #77788D
 96" WIDE DESIGNER WOOD LOCKER BENCH
 96" W x 18" H x 9-1/2" D

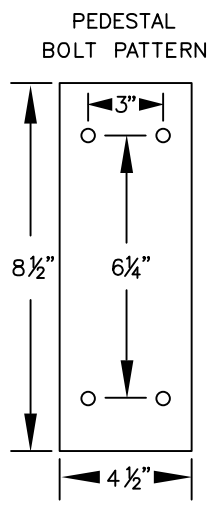

MODEL #77788D

96" WIDE DESIGNER WOOD
LOCKER BENCH

AVAILABLE FINISHES:
GRAY, BLUE, BLACK,
MAPLE, CHERRY OR MAHOGANY

DRAWN: 7/2020

Established in 1936, Salsbury Industries is the industry leader in manufacturing and distributing quality lockers.

18300 CENTRAL AVENUE
 CARSON, CA 90746-4008
 PHONE: (800) 562-5377
 FAX: (800) 562-5399
 email: engineering@lockers.com

MODEL #77783D
36" W x 18" H x 9-1/2" D

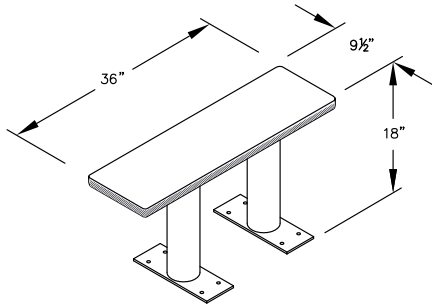

MODEL #77784D
48" W x 18" H x 9-1/2" D

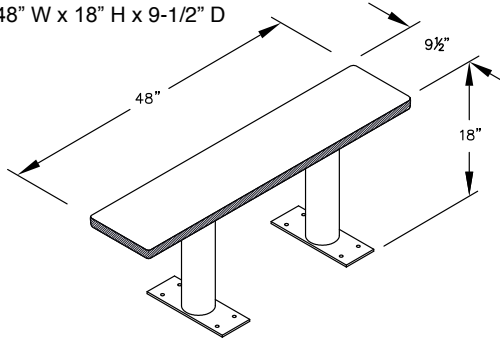

MODEL #77785D
48" W x 18" H x 9-1/2" D

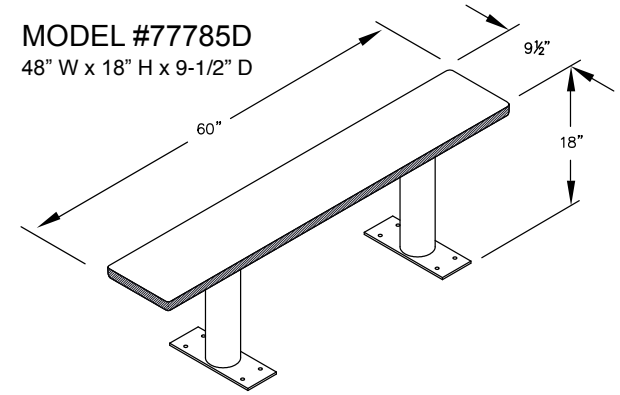

MODEL #77786D
60" W x 18" H x 9-1/2" D

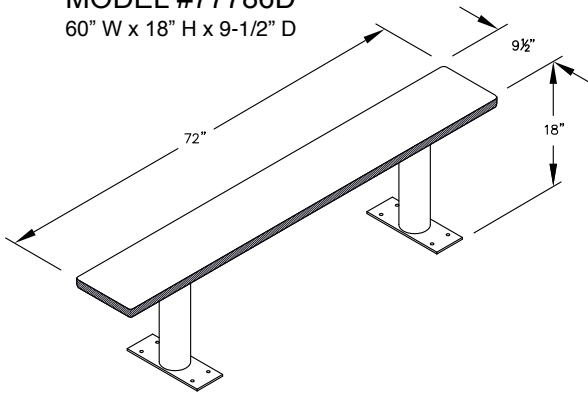

MODEL #77787D
72" W x 18" H x 9-1/2" D

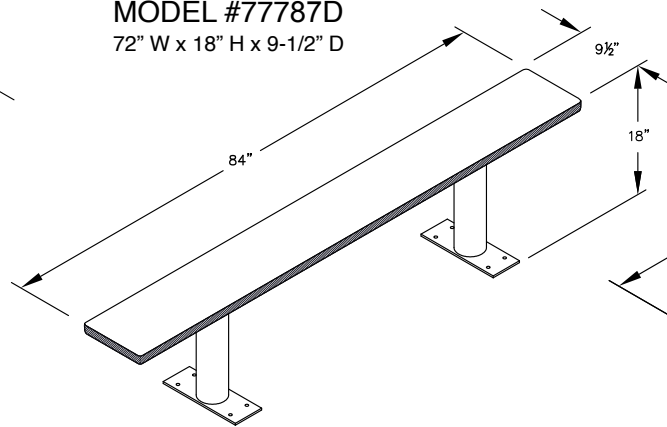

MODEL #77788D
96" W x 18" H x 9-1/2" D

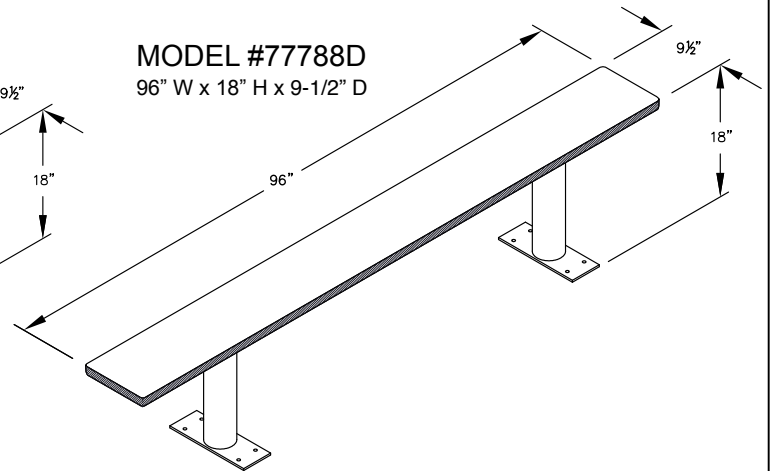

PEDESTAL BOLT PATTERN

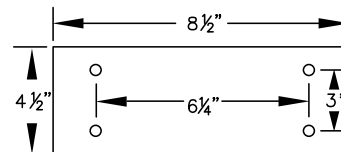

DESIGNER WOOD LOCKER BENCHES

- MODEL #77783D (36" Wide)
- MODEL #77784D (48" Wide)
- MODEL #77785D (60" Wide)
- MODEL #77786D (72" Wide)
- MODEL #77787D (84" Wide)
- MODEL #77788D (96" Wide)

DRAWN: 7/2020

Established in 1936, Salsbury Industries is the industry leader in manufacturing and distributing quality lockers.

18300 CENTRAL AVENUE
CARSON, CA 90746-4008
PHONE: (800) 562-5377
FAX: (800) 562-5399
email: engineering@lockers.com