

(NOTE: SEE-THROUGH DESIGNER LOCKER SHOWN WITHOUT SIDE PANEL OR SLOPING HOOD. PLEASE ORDER SEPARATELY.)

MODEL #S-33165
 TRIPLE TIER - 1 WIDE
 SEE-THROUGH DESIGNER LOCKER
 (3) LOCKER COMPARTMENTS
 EACH COMPARTMENT:
 10 3/4" W x 22 3/4" H x 13 3/4" D
 EACH POLYCARBONATE WINDOW:
 4" W x 12 1/2" H

SIDE VIEW

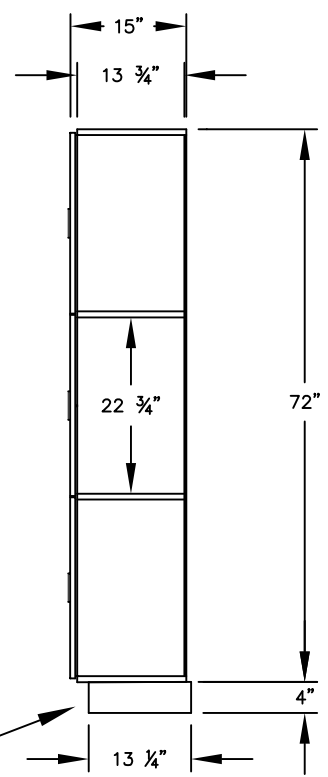

(BASES ARE MADE OF INDUSTRIAL GRADE PARTICLEBOARD AND ARE COVERED IN A DURABLE BLACK LAMINATE. PLEASE SET BASE TO ALLOW 5/8" BETWEEN THE BACK OF THE LOCKER AND THE WALL FOR AIR VENTILATION.)

MODEL #S-33165

12" WIDE TRIPLE TIER
 SEE-THROUGH DESIGNER WOOD LOCKER
 SIX FEET HIGH (ADD 4" FOR BASE)

AVAILABLE FINISHES: GRAY, BLUE, BLACK,
 MAPLE, CHERRY OR MAHOGANY

DRAWN: 07/18

Established in 1936, Salsbury Industries is the industry leader in manufacturing and distributing quality lockers.

1010 E. 62ND STREET
 LOS ANGELES, CA 90001
 PHONE: (800) 562-5377
 FAX: (800) 562-5399
 email: engineering@lockers.com