

(NOTE: SEE-THROUGH DESIGNER LOCKER SHOWN WITHOUT SIDE PANEL OR SLOPING HOOD. PLEASE ORDER SEPARATELY.)

MODEL #S-34165
FOUR TIER - 1 WIDE
SEE-THROUGH DESIGNER LOCKER

(4) LOCKER COMPARTMENTS

EACH COMPARTMENT:
10 $\frac{3}{4}$ " W x 17" H x 13 $\frac{3}{4}$ " D

EACH POLYCARBONATE WINDOW:
3 $\frac{1}{2}$ " W x 9" H

(BASES ARE MADE OF INDUSTRIAL GRADE PARTICLEBOARD AND ARE COVERED IN A DURABLE BLACK LAMINATE. PLEASE SET BASE TO ALLOW $\frac{5}{8}$ " BETWEEN THE BACK OF THE LOCKER AND THE WALL FOR AIR VENTILATION.)

SIDE VIEW

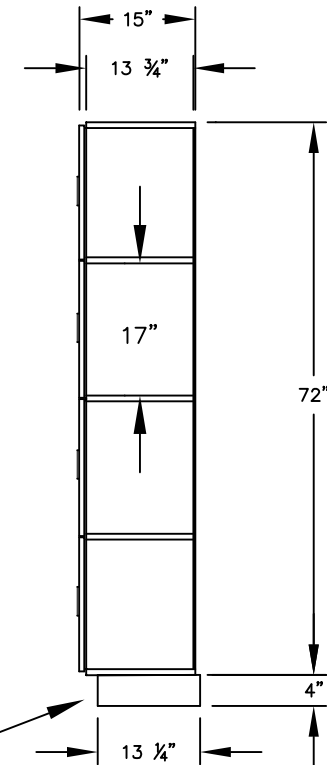

MODEL #S-34165

12" WIDE FOUR TIER
SEE-THROUGH DESIGNER WOOD LOCKER
SIX FEET HIGH (ADD 4" FOR BASE)

AVAILABLE FINISHES: GRAY, BLUE, BLACK,
MAPLE, CHERRY OR MAHOGANY

DRAWN: 07/18

Established in 1936, Salsbury Industries is the industry leader in manufacturing and distributing quality lockers.

1010 E. 62ND STREET
LOS ANGELES, CA 90001
PHONE: (800) 562-5377
FAX: (800) 562-5399
email: engineering@lockers.com