

Plastic Lockers – 92000 Series

Models 92168 & 92368 Double Tier

Assembly Instructions

Thank you for selecting Salsbury 92000 Series Plastic Lockers. We are confident that the quality and construction of the lockers will prove to be a good investment. These instructions are intended to assist you in the assembly of the lockers. Individual job conditions will dictate whether the lockers must be anchored to the wall, the floor, or both. **Please read the entire assembly instruction document before beginning assembly.**

Step 1. Insert the back panel tabs into the pockets along the rear edge of the side panel. Tap with soft mallet to engage two (2) latch points.



Step 2. Press another side panel onto the tabs on the other side of the back panel. Tap to engage as above.

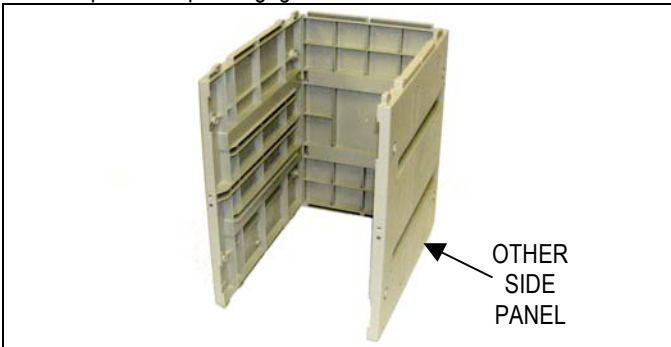

Step 3. Join and press down the sides-and-back-panel assembly from step 2 above into the base panel as shown below. The base panel is the thicker of the three (3) horizontal panels provided. Then thread four (4) leveling feet provided into the bottom of the base panel.

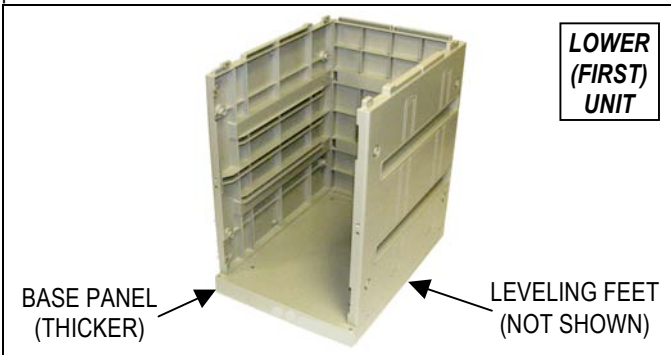

Step 4. Join two long interlocking plastic joint pieces and one short interlocking plastic joint piece into a U-shaped assembly as shown below. Press the U-shape assembly down onto the U-shaped top edges of the lower (first) unit assembly from step 3.

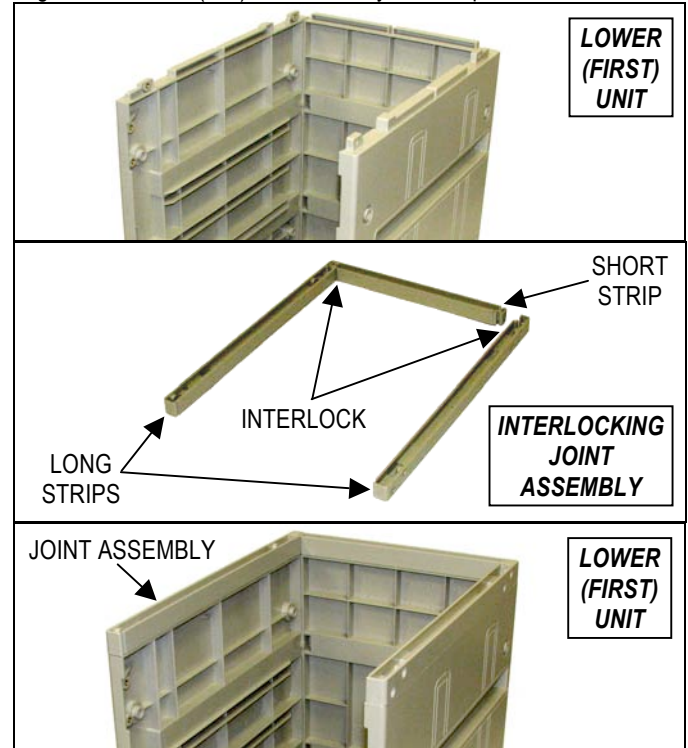

Step 5. Assemble a second unit per Steps 1 and 2. Press this assembly into the joint assembly on the top of the lower half of the unit from Step 4 above. Then press down one of the two top panels (thinner) onto the top of the assembly.

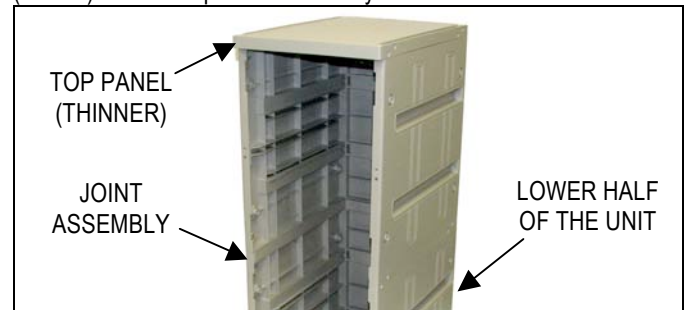

SALSBURY INDUSTRIES

1010 East 62nd Street, Los Angeles, CA 90001-1598
 Phone: 1-800-562-5377 Int'l Phone: 323-846-6700
 Fax: 1-800-562-5399 Int'l Fax: 323-846-6800
 www.lockers.com engineering@lockers.com

Plastic Lockers – 92000 Series

Models 92168 & 92368 Double Tier

Assembly Instructions

Step 6. If you purchased the optional Sloping Hood, do not install the Topmost Panel until you have first completed 'Step 6A'. If you are NOT using a Sloping Hood, install filler strips (provided) into the Topmost panel recesses.

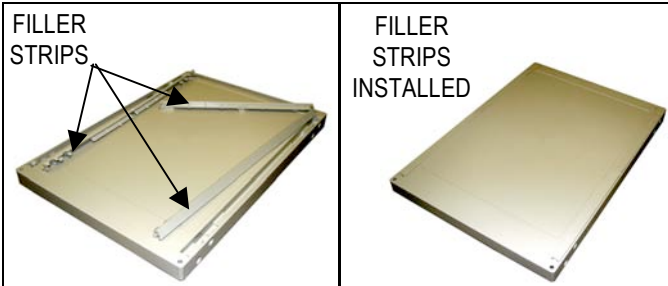

Step 6A. Install the optional Sloping Hood to the Topmost Panel as follows: Place the hood upside down on carpet or another protective surface. Take the Topmost panel (also upside down) and lay it over the bottom of the hood, keeping the tabs 'inside' the panel. Align one side's tabs with the panel slots and press or tap with a rubber mallet to snap-fit them. Align the 2 tabs on the back with their slots and press down on the panel. Align the last side's 2 tabs with their slots (it may take inserting a screwdriver between the hood and panel to 'pull' the hood's side out to get them aligned), and press down on the panel to complete the tab and slot joining.

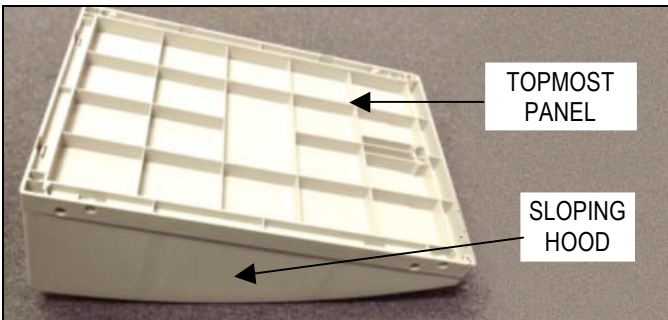

Step 7. Assemble a second compartment per Steps 1 through 5 except without a base. (This unit will not have leveling feet.) Stack this second unit onto the first unit as shown, using a rubber mallet if necessary.

If the optional Sloping Hood is being used and it has already been assembled to the Topmost Panel per Step 6A, you can now install it with the screws and hole covers into the adjoining side panels. If NOT using a Sloping hood, you can install the Topmost Panel prior to stacking the second unit.

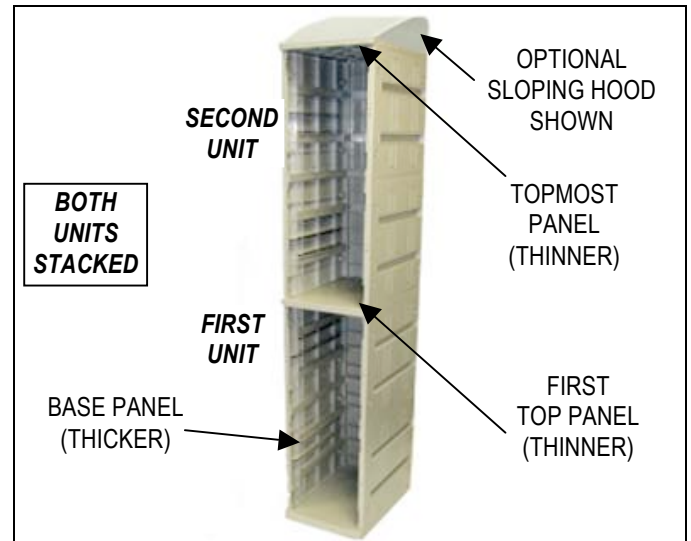

Step 8. Install screws and hole covers where side panels join to top panels and base panel. There are 18 screws and hole covers on each side of the two sides of the assembly (36 in total).



SALSBURY INDUSTRIES

1010 East 62nd Street, Los Angeles, CA 90001-1598
 Phone: 1-800-562-5377 Int'l Phone: 323-846-6700
 Fax: 1-800-562-5399 Int'l Fax: 323-846-6800
 www.lockers.com engineering@lockers.com

Plastic Lockers – 92000 Series

Models 92168 & 92368 Double Tier

Assembly Instructions

Step 9. Install a lock catch bar at the center of each of the two (2) compartments, on the left front inside edge of the side panel with the four (4) short flathead screws provided.

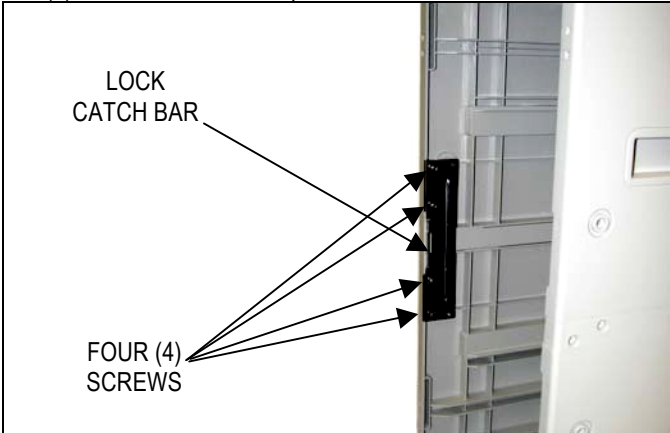

Step 10. Attach the plastic oval lock plate to the front of the two (2) doors with two (2) screws from the rear of the door. Insert the stainless steel hasp through hole in front of doors making sure cutout is facing downward. Secure by threading nut provided onto it from rear. Insert lock knob through hasp from front of door making sure hole in lock knob is facing downward. Attach cam to rear of lock knob shaft with screw provided. Be sure the cam is pointing toward the outside of the door and is properly engaged with the square shaft end of the lock knob.

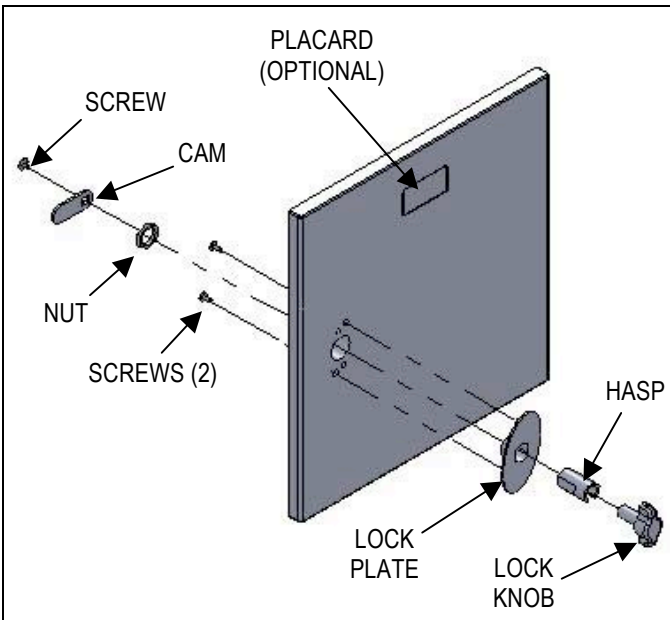

Step 11. Fasten the eight (8) hinges (four (4) for each of the two (2) doors) provided in the hardware package securely to each hinge position with the screws provided as shown below. Fasten each of the two (2) doors to the appropriate set of hinges.



SALSBURY INDUSTRIES

1010 East 62nd Street, Los Angeles, CA 90001-1598
 Phone: 1-800-562-5377 Int'l Phone: 323-846-6700
 Fax: 1-800-562-5399 Int'l Fax: 323-846-6800
 www.lockers.com engineering@lockers.com

Plastic Lockers – 92000 Series

Models 92168 & 92368 Double Tier

Assembly Instructions

Step 12. Install coat rods by pressing ends into locating tabs near top of compartment. Use the locating tabs behind the stiffener rib.



Step 13. Slide the shelves (optional) into the slots in the locker side panels. There are six (6) slots available for shelves in each of the two (2) compartments.

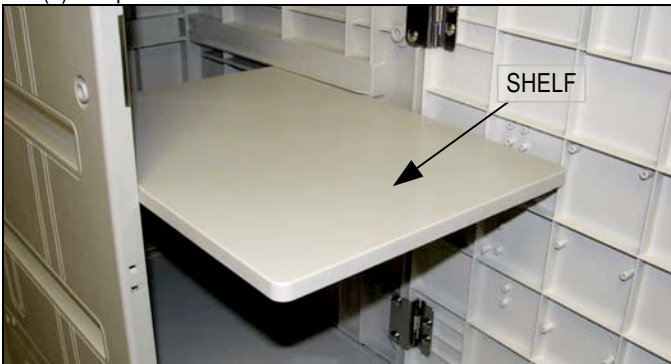

Step 14. Install placards (optional) in the indentation near the top of each door.

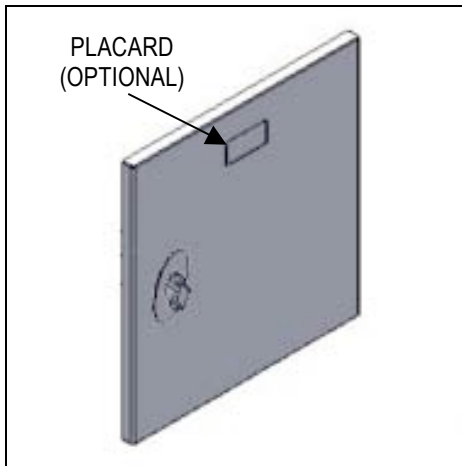

Step 16. If two (2) or more lockers are to be installed side by side, the lockers should be fastened together with the four (4) nuts and long screws provided. Select two (2) available holes toward the front and any two (2) holes toward the rear. The illustration below shows the 12 holes that are available. The lower illustration shows the inside view of a hole and screw.

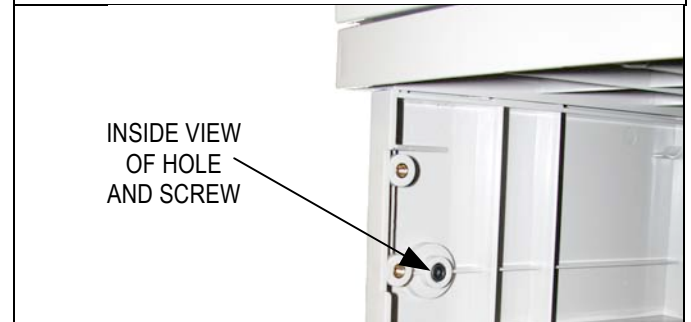
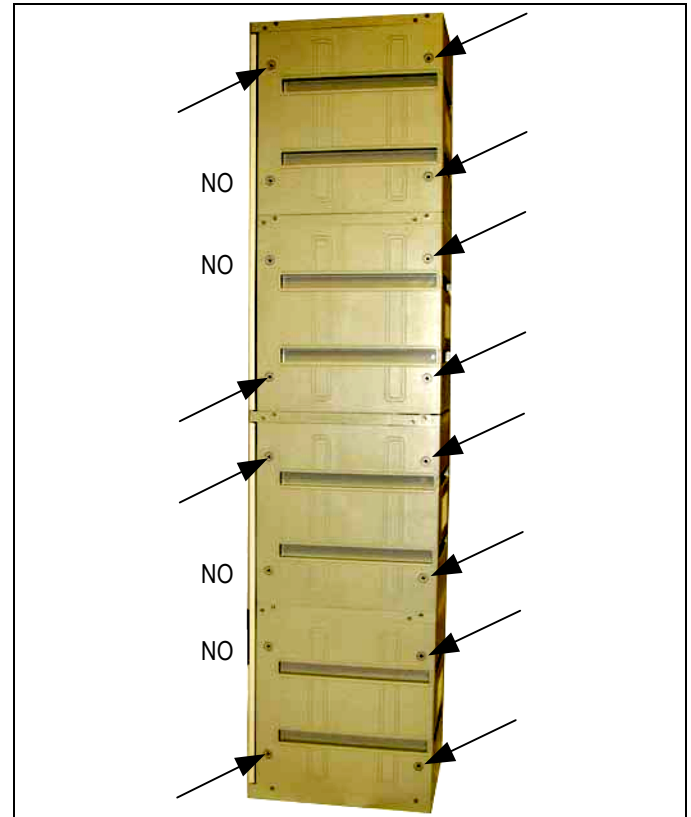

The assembly of the plastic lockers is now complete.

SALSBURY INDUSTRIES

1010 East 62nd Street, Los Angeles, CA 90001-1598
 Phone: 1-800-562-5377 Int'l Phone: 323-846-6700
 Fax: 1-800-562-5399 Int'l Fax: 323-846-6800
 www.lockers.com engineering@lockers.com